



COMETAL SA

FABBRICA DI LAMELLE, ROLLADEN, GELOSIE E TENDE DA SOLE



LAMELLA | AV 90 - AV 70

Senza ombra di dubbio

 swiss made

www.cometal.ch

LAMELLA | AV 90 - AV 70

Lamella con collegamenti verticali a vista.

Le lamelle AV90 e AV70 sono un prodotto moderno di oscuramento. Ogni stecca è guidata all'interno della guida tramite un clips alternato a sinistra e destra. Verniciatura delle stecche ad alta resistenza alle intemperie e a mantenimento del colore negli anni. In opzione possibilità di automatizzare il funzionamento tramite motore inserito direttamente nel canale della lamella.

OPZIONI:

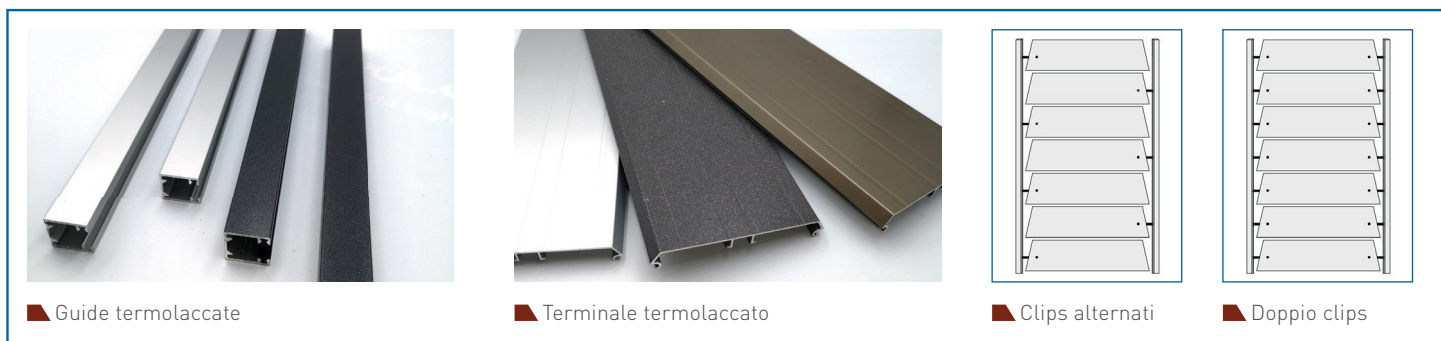

AV 90 - AV 70

- Copertura grandi dimensioni
- Scaletta sostituibile
- Regolazione individuale

Misure



Minima: 0,6 m
Massima: 4,5 m



Minima: 0,56 m
Massima: 4,0 m

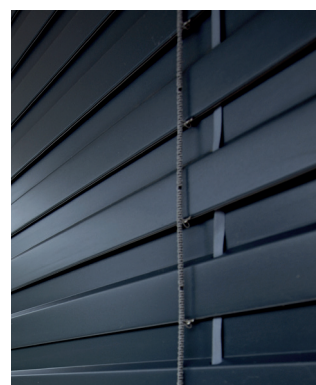



VASTA GAMMI DI COLORI

I nostri prodotti sono disponibili in molte varianti di colore.
(colori disponibili a magazzino)

LAMELLA | AV 90 - AV 70



120 Terracotta
(ca. RAL 3013)

NCS-S 3560-Y80R

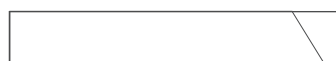

010 Bianco
(ca. RAL 9003)

NCS-S 0502-B



276 Grigio Antracite
(RAL 7016)



110 Beige
(ca. RAL 1019)

NCS-S 4010-Y50R



907 Grigio Alluminio
(ca. RAL 9007)



240 Beige Chiaro

NCS-S 2010-Y30R



140 Alluminio
(ca. RAL 9006)



071 Marrone Challet
(ca. RAL 8014)

NCS-S 8010-Y50R



130 Grigio
(ca. RAL 7038)

NCS-S 3000-N



780 Bronzo

Ulteriori colori disponibili con possibile supplemento di costo.



COMETAL^{SA}

FABBRICA DI LAMELLE, ROLLADEN, GELOSIE E TENDE DA SOLE



COMETAL SA

FABBRICA DI LAMELLE, ROLLADEN, GELOSIE E TENDE DA SOLE

COMETAL SA

Via Cantonale, 121 - 6595 Riazzino, Svizzera

Tel. +41 91 859 10 22 - Fax +41 91 859 27 03

e-mail: info@cometal.ch - www.cometal.ch



Altezza luce (hl)

Altezza architrave (hs)

	a mano/a motore	
	AV-90	AV-70
1010-1250	180	180
1251-1500	200	200
1501-1750	220	220
1751-2000	230	230
2001-2250	250	250
2251-2500	260	270
2501-2750	280	290
2751-3000	290	300
3001-3250	310	320
3251-3500	320	340
3501-3750	340	360
3751-4000	350	380

Misure massime

Singole

Accoppiati

	Singole		Accoppiati	
	a mano	a motore	a mano	a motore
Altezza luce (hl) min.	0,50 m	0,50 m	0,50 m	0,50 m
Altezza luce (hl) max.	4,0 m	4,0 m	4,0 m	4,0 m
Larghezza della costruzione (bk) min.	0,6 m	0,6 m	-	-
Larghezza della costruzione (bk) max.	4,0 m	4,5 m	-	-
Superficie massima	8 mq.	10 mq.	10 mq.	24 mq.

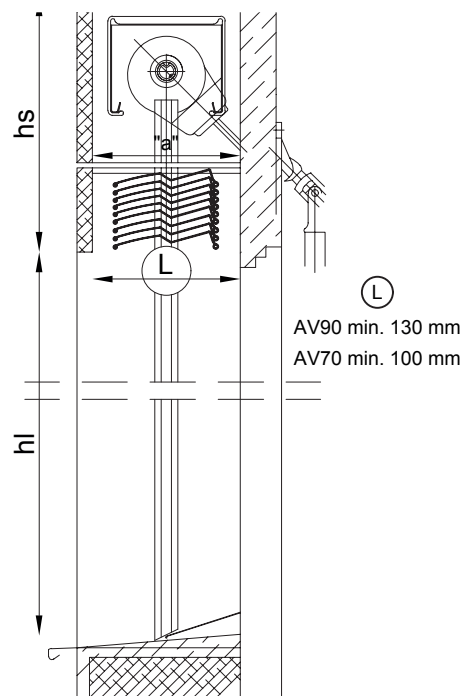

■ Esempio di montaggio

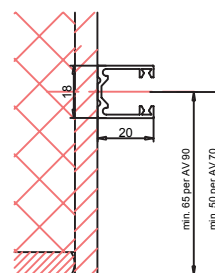

■ Guida su intonaco

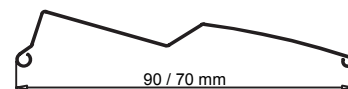

■ Profilo AV90 - AV 70

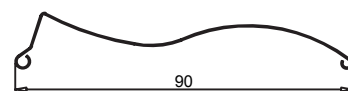

■ Profilo A590

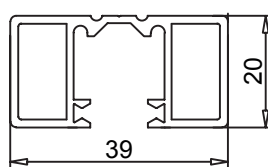
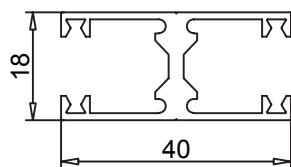
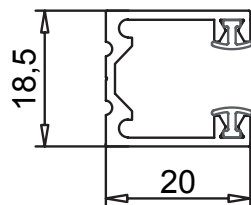
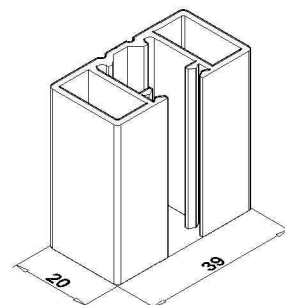
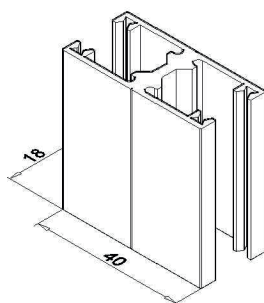
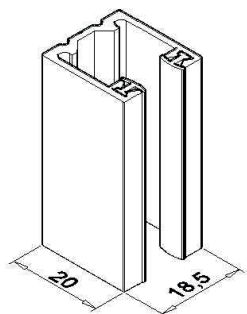

■ Guida

■ Guida Doppia

■ Guida Autoportante